



E I C H H O L T Z

110661 DINING TABLE TURNER

ASSEMBLY INSTRUCTION

PARTS

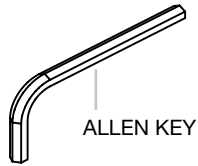
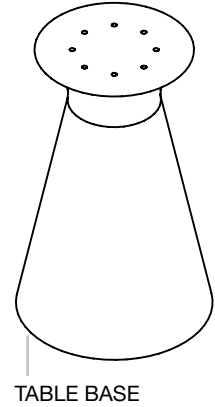
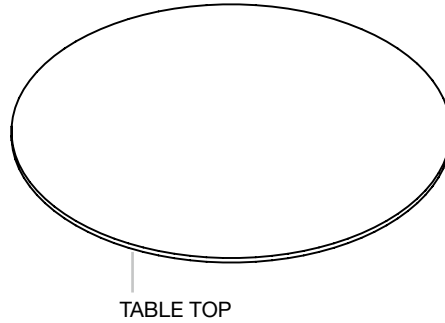
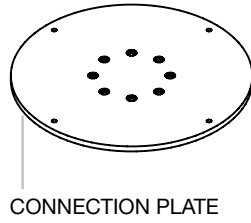
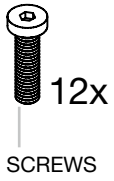

1

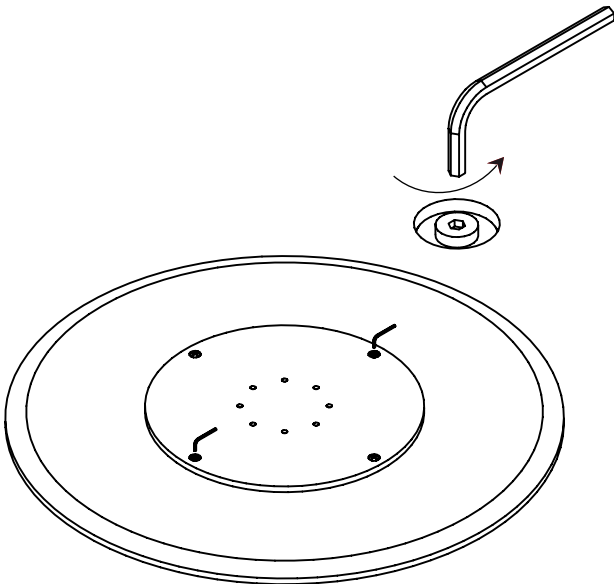

2

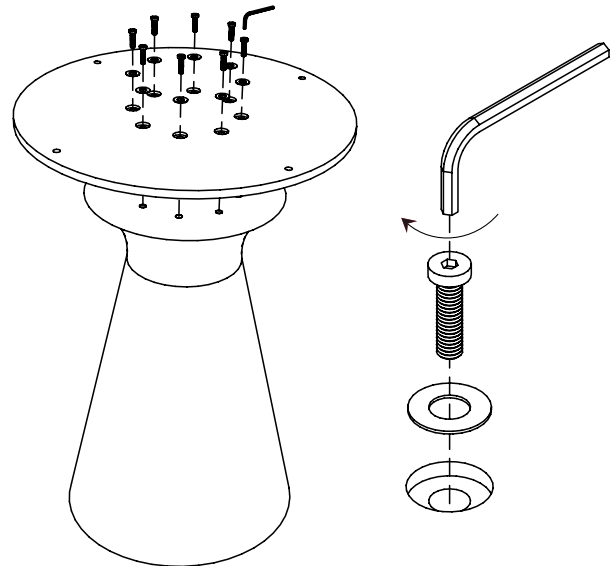

3

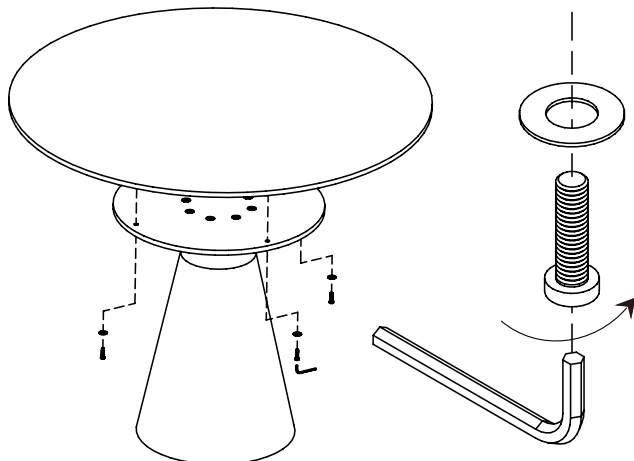

Make sure to place all parts on a carpeted or padded area to avoid damaging the materials.

Do **NOT** use power tools!

Step 1 : Detach the connection plate from the top

Step 2 : Fix the connection plate on the base

Step 3 : Fix the top to the base

