

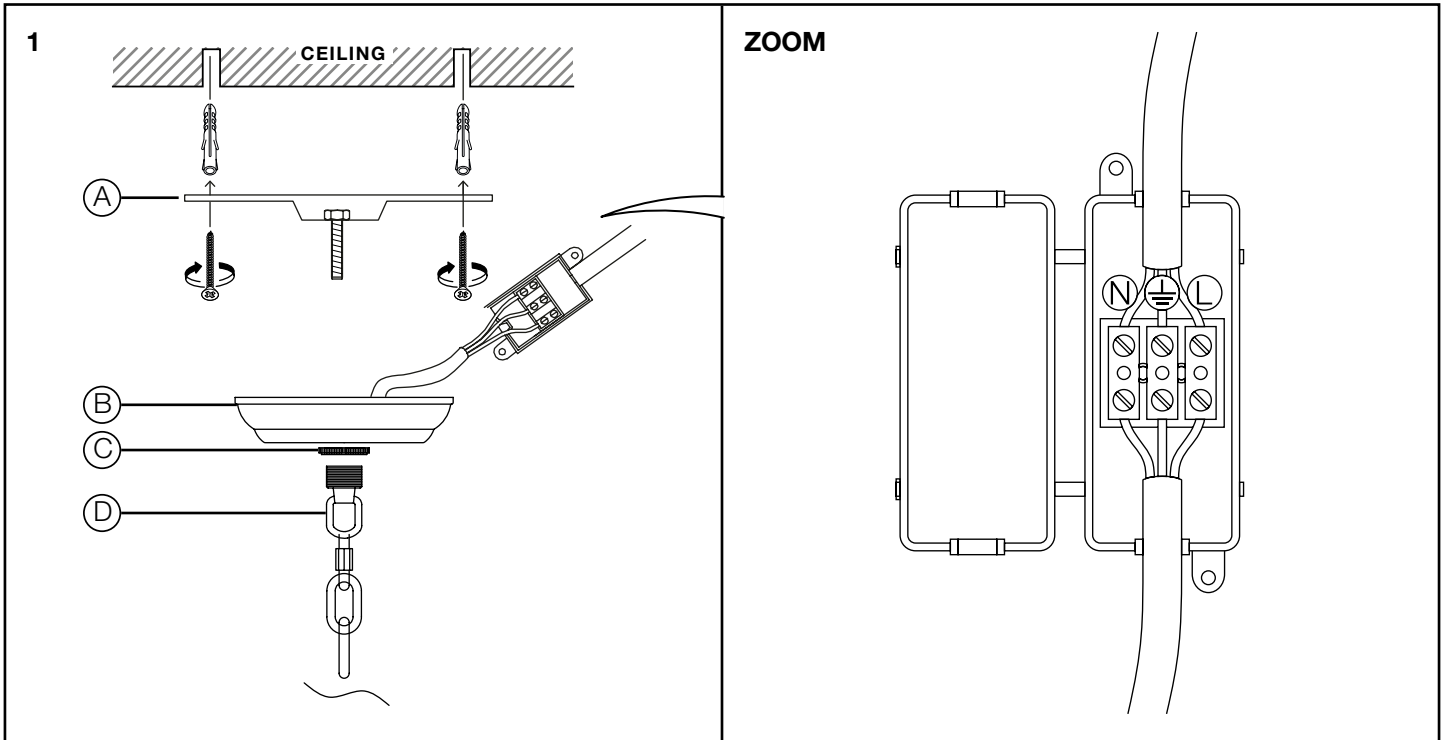

E I C H H O L T Z

111904 CHANDELIER MURANO

ASSEMBLY INSTRUCTION



Two people are required for safe mounting of this luminaire.

Turn off the electricity supply at the main circuit panel before installing. Do not connect the electricity supply until your luminaire is fully assembled and installed.

Fix the ceiling bracket (A) to the ceiling by using mounting plugs and screws suitable to your ceiling type.

Remove the lamp from the carton by lifting the bar. Hold the luminaire in the air while removing the protective packaging materials. Do not place the luminaire on a table, floor etc as it might cause it to break.

Hold the lamp in an elevated position in such a way that the wires can freely reach the ceiling junction box.

Thread the wires through the components (suspension eye (D), retaining nut (C), ceiling canopy (B)) and connect the 3 power wires according to their colours. Brown is the live wire, blue is the neutral wire, green/yellow is the earth wire.

Screw the suspension eye (with retaining nut attached) to the ceiling bracket and fix it securely by tightening the retaining nut.

Check whether the connection is sufficiently strong by manually loading the chain. Carefully lower the lamp until the chain is taut. Straighten the chain links.

**CARE INSTRUCTION**

Wipe clean with soft, dry cloth.

Always avoid the use of harsh chemicals or abrasive cleaners as they may cause damage to the fixture's finish.

