



E I C H H O L T Z

109083 DINING TABLE DRUMMOND

ASSEMBLY INSTRUCTION

PARTS

1x

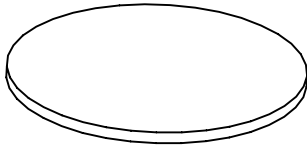

(A)

1x

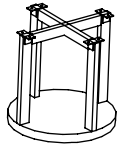

(B)

1x



(C)

1x

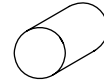

(D)

4x

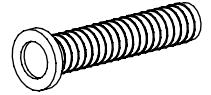

(E)

1

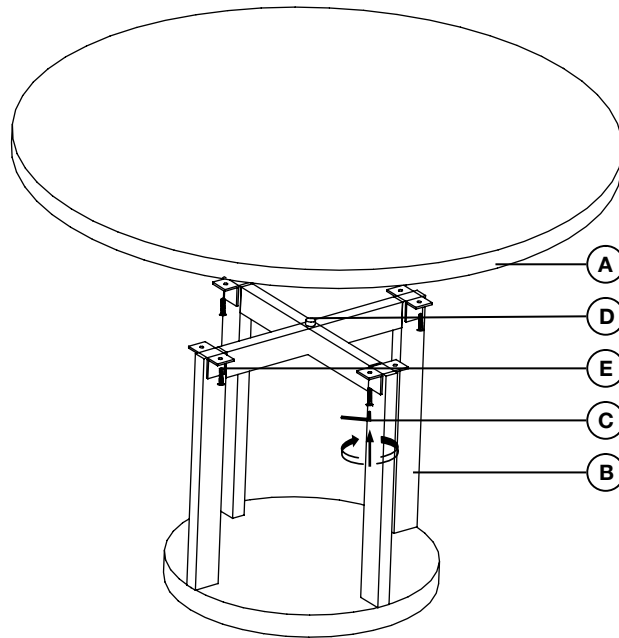

FINAL

